

MODULO DI RICHIESTA

Calcolo Molle a torsione

Inserire i dati dell'etichetta CE posta a lato della porta:



Marca della porta =	
Tipo di porta (Type) =	
Larghezza x Altezza (mm)	
Peso (Weight) in Kg =	
Molle (Springs) in mm =	
Giri di carica (Turn) =	

Indicare le Specifiche della Porta Sezionale

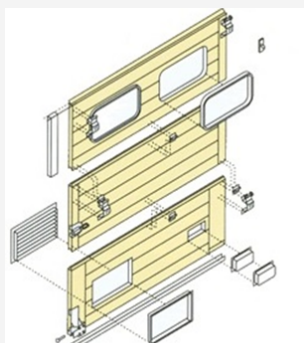

ACCESSORI	NUMERO
<input type="checkbox"/> Porta Pedonale	
<input type="checkbox"/> Finestre	
<input type="checkbox"/> Griglie	
<input type="checkbox"/> Pannelli	
<input type="checkbox"/> Rinforzi/ omega	

Indicare il tipo di apertura







<input type="checkbox"/> Scorrimento a 90°	<input type="checkbox"/> Scorrimento architrave rialzata	<input type="checkbox"/> Scorrimento Verticale

Prendere le seguenti misure



Altezza architrave (mm) =	
Larghezza porta (mm) =	
Altezza porta (mm) =	
Peso della porta (Kg) =	

Indicare i componenti presenti sull'albero molle

<p>CAVI</p>		<ul style="list-style-type: none"> <input type="checkbox"/> <i>D = 3 mm L = 3000 mm</i> <input type="checkbox"/> <i>D = 3 mm L = 4000 mm</i> <input type="checkbox"/> <i>D = 4 mm L = 3000 mm</i> <input type="checkbox"/> <i>D = 4 mm L = 4000 mm</i> <input type="checkbox"/> <i>D = 4 mm L = 5000 mm</i> <input type="checkbox"/> <i>D = 4 mm L = 6000 mm</i> <input type="checkbox"/> <i>D = 4 mm L = 9000 mm</i> <input type="checkbox"/> <i>D = 5 mm L = 6000 mm</i>
<p>TAMBURI</p>		<ul style="list-style-type: none"> <input type="checkbox"/> <i>124 x 46 per porte h max 2490, cavo filo 3 mm</i> <input type="checkbox"/> <i>85 x 85 per porte h max 3000, cavo filo 3 mm</i> <input type="checkbox"/> <i>88 x 71 per porte h max 3000, cavo filo 4 mm</i> <input type="checkbox"/> <i>126 x 86 per porte h max 3761, cavo filo 4 mm</i> <input type="checkbox"/> <i>126 x 86 per porte h max 3965, cavo filo 4 mm</i> <input type="checkbox"/> <i>52 x 97 per porte h max 5230, cavo filo 5 mm</i>
<p>ALBERO</p>		<ul style="list-style-type: none"> <input type="checkbox"/> <i>tubolare scanalato</i> <input type="checkbox"/> <i>tubolare pieno</i>
<p>ANTIROTTIRA</p>		<ul style="list-style-type: none"> <input type="checkbox"/> <i>molle</i> <input type="checkbox"/> <i>cavi</i>
<p>RUOTE</p>		<ul style="list-style-type: none"> <input type="checkbox"/> <i>lunghe 120 mm</i> <input type="checkbox"/> <i>lunghe 200 mm</i>
<p>GIUNTO</p>		<ul style="list-style-type: none"> <input type="checkbox"/> <i>regolabile</i> <input type="checkbox"/> <i>fisso</i>